

# PARTS DIAGRAM

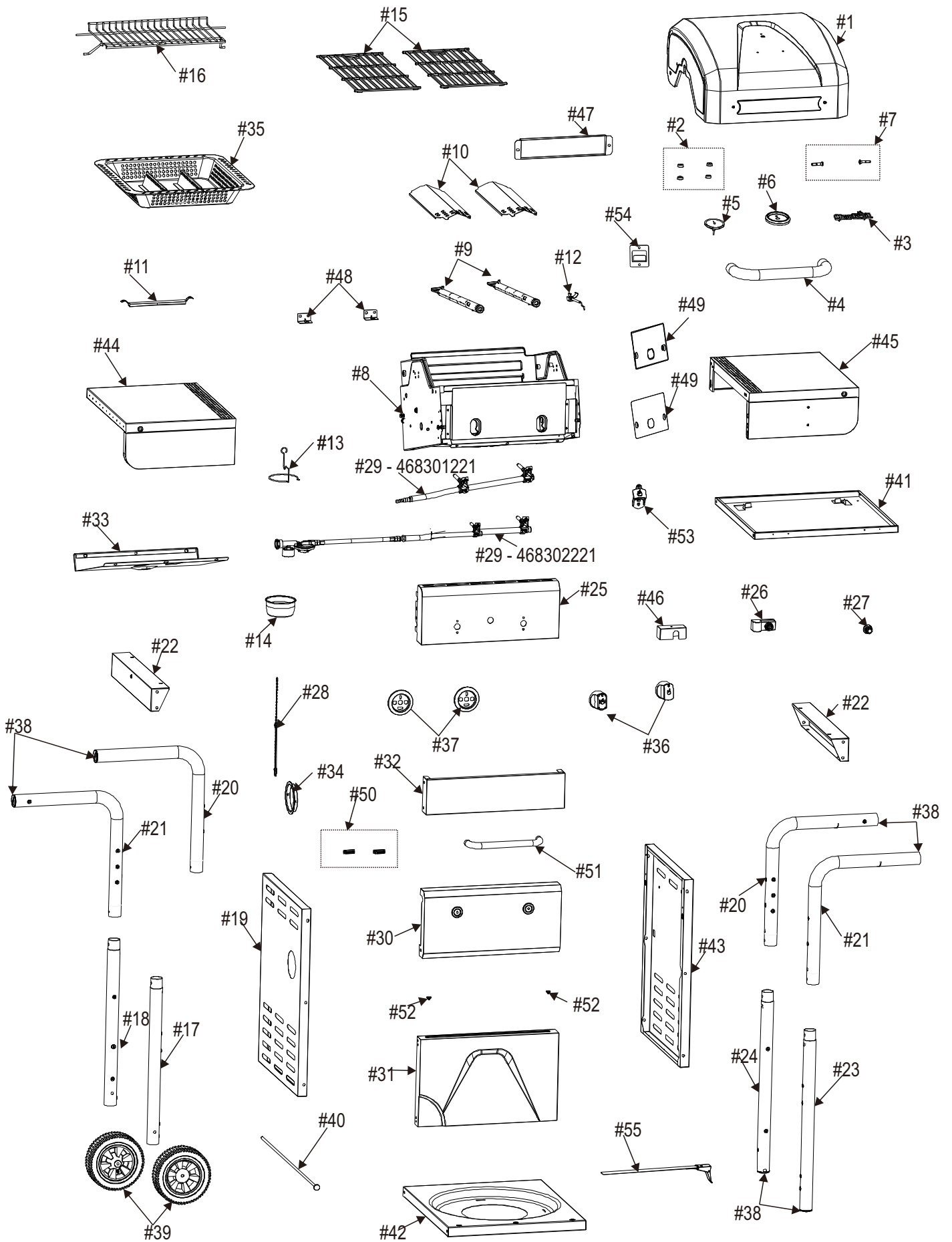

## PARTS LIST







| Key | Qty | Description                  |
|-----|-----|------------------------------|
| 1   | 1   | TOP LID                      |
| 2   | 4   | LID BUMPER                   |
| 3   | 1   | LOGO PLATE                   |
| 4   | 1   | HANDLE                       |
| 5   | 1   | TEMPERATURE GAUGE            |
| 6   | 1   | BEZEL, TEMPERATURE GAUGE     |
| 7   | 1   | HARDWARE F/ TOP LID          |
| 8   | 1   | FIREBOX                      |
| 9   | 2   | BURNER                       |
| 10  | 2   | HEAT TENT                    |
| 11  | 1   | FLAME CARRYOVER TUBE         |
| 12  | 1   | ELECTRODE                    |
| 13  | 1   | GREASE CUP CLIP              |
| 14  | 1   | GREASE CUP                   |
| 15  | 2   | COOKING GRATE                |
| 16  | 1   | SWINGAWAY RACK               |
| 17  | 1   | LEG, LEFT LOWER FRONT        |
| 18  | 1   | LEG, LEFT LOWER REAR         |
| 19  | 1   | LEFT SIDE PANEL, F/ CART     |
| 20  | 2   | UPPER CART FRAME A           |
| 21  | 2   | UPPER CART FRAME B           |
| 22  | 2   | UPPER CART BRACE             |
| 23  | 1   | LEG, RIGHT LOWER FRONT       |
| 24  | 1   | LEG, RIGHT LOWER REAR        |
| 25  | 1   | CONTROL PANEL                |
| 26  | 1   | ELECTRONIC IGNITION MODULE   |
| 27  | 1   | BUTTON, F/ EI MODULE         |
| 28  | 1   | MATCH HOLDER                 |
| 29  | 1   | VALVE ASSEMBLY               |
| 30  | 1   | FRONT PANEL, DOOR, NO HANDLE |
| 31  | 1   | FRONT PANEL, LOWER           |
| 32  | 1   | FRONT PANEL, UPPER           |
| 33  | 1   | HEAT SHIELD, TANK            |
| 34  | 1   | GROMMET, F/ REGULATOR HOLE   |
| 35  | 1   | CHARCOAL TRAY                |
| 36  | 2   | CONTROL KNOB                 |
| 37  | 2   | BEZEL, F/ CONTROL KNOB       |
| 38  | 6   | END CAP, F/ LEG              |
| 39  | 2   | WHEEL                        |

| Key | Qty | Description               |
|-----|-----|---------------------------|
| 40  | 1   | AXLE                      |
| 41  | 1   | STORAGE TRAY              |
| 42  | 1   | BOTTOM SHELF              |
| 43  | 1   | RIGHT SIDE PANEL, F/ CART |
| 44  | 1   | LEFT SHELF ASSEMBLY       |
| 45  | 1   | RIGHT SHELF ASSEMBLY      |
| 46  | 1   | HEAT SHIELD, F/ EI MODULE |
| 47  | 1   | HEAT SHIELD, F/ HANDLE    |
| 48  | 2   | BURNER BRACE              |
| 49  | 2   | HEAT SHIELD, F/ FIREBOX   |
| 50  | 1   | MAGNET, F/ DOOR           |
| 51  | 1   | HANDLE, F/ DOOR           |
| 52  | 2   | BUMPER, F/ DOOR           |
| 53  | 1   | BOTTLE OPENER             |
| 54  | 1   | GRATE TOOL HOLDER         |
| 55  | 1   | TANK STRAP                |

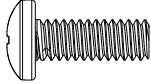
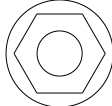
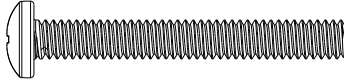
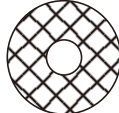
### NOT Pictured

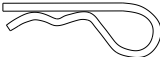
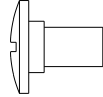
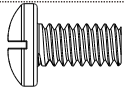
|     |   |                       |
|-----|---|-----------------------|
| ... | 1 | HARDWARE PACK         |
| ... | 1 | PRODUCT GUIDE, EUROPE |
| ... | 1 | GRATE TOOL            |

## HARDWARE LIST

| Key | Description               | Picture   | Qty |
|-----|---------------------------|---|-----|
| A   | 1/4-20x3/4" Machine Screw |    | 48  |
| B   | 1/4-20 Flange Nut         |    | 8   |
| C   | 1/4-20x2" Machine Screw   |     | 4   |
| D   | 7x15 Fiber Washer         |    | 4   |
| E   | Bushing                   |    | 1   |
| F   | Hitch Pin Clip            |   | 1   |
| L   | Shoulder Screw            |  | 2   |
| M   | #10-24x3/8" Machine Screw |  | 2   |
| N   | 5mm Lock Washer           |  | 2   |
| P   | 5mm Flat Washer           |  | 2   |
| Q   | #10-24x3/8" Screw         |  | 2   |
| R   | #10-24 Flange Nut         |  | 2   |