

PARTS DIAGRAM - 468922525, 468922725

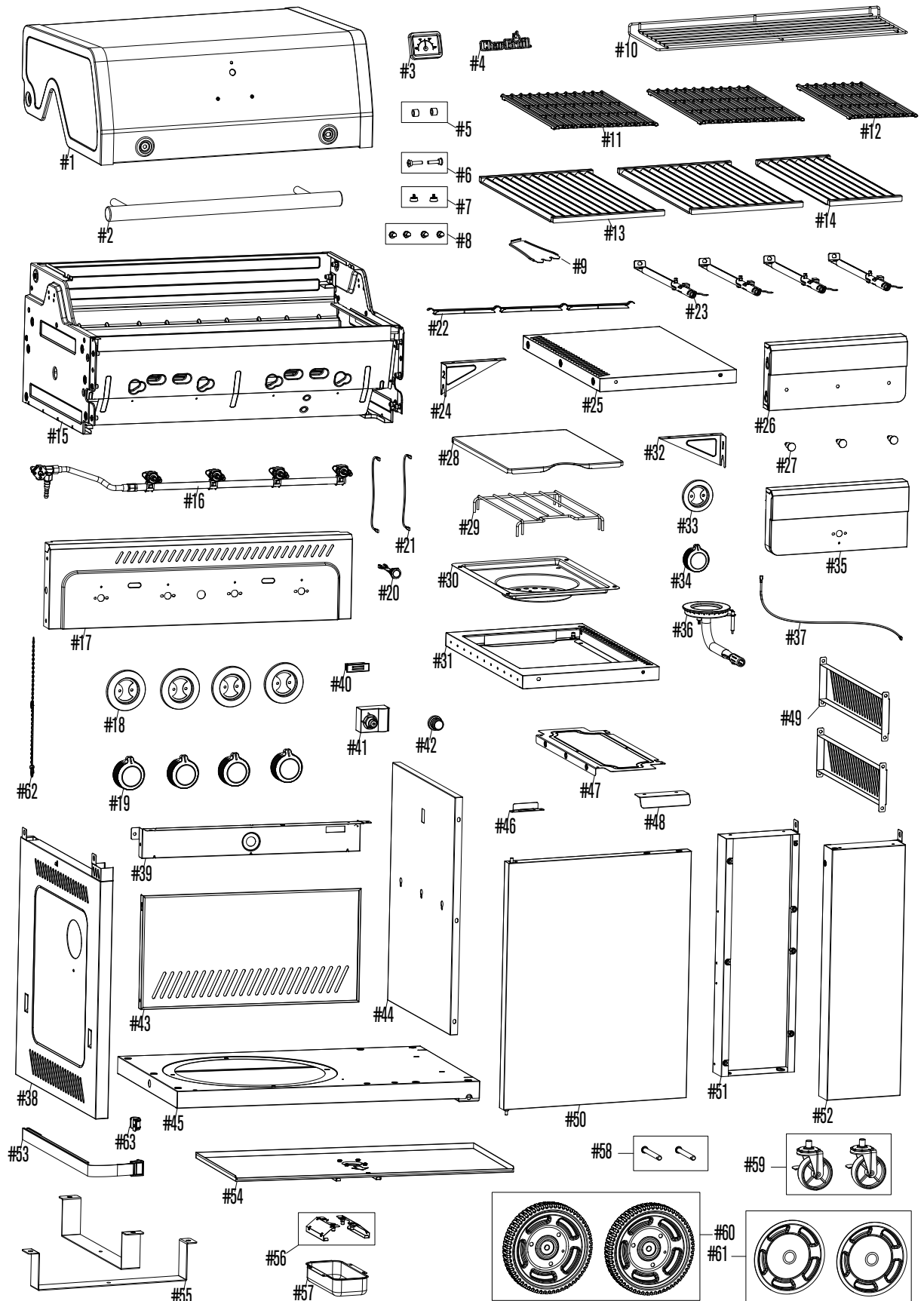

PARTS DIAGRAM - 468923525

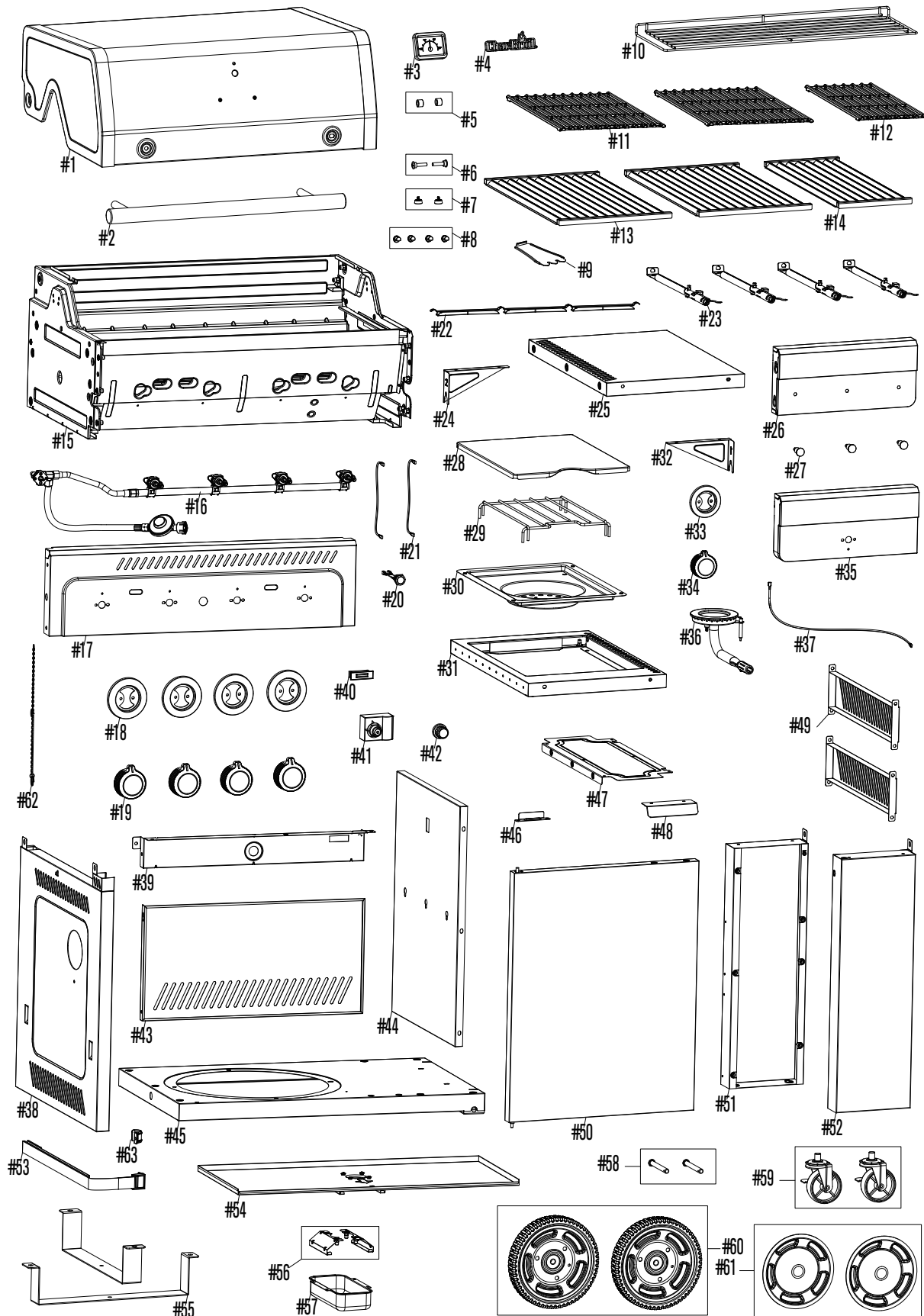

PARTS LIST - 468922525, 468922725

Key	Qty	Description
1	1	TOP LID
2	1	LID HANDLE
3	1	TEMPERATURE GAUGE
4	1	LOGO PLATE
5	2	RUBBER BUMPER,LID STOP
6	2	TOP LID HARDWARE
7	2	RUBBER BUMPER,LID
8	4	TUBE BURNER BRACE
9	1	IR CLEANING TOOL
10	1	WARMING RACK
11	2	COOKING GRATE BIG
12	1	COOKING GRATE SMALL
13	2	EMITTERS F/COOKING GRATE BIG
14	1	EMITTERS F/COOKING GRATE SMALL
15	1	FIREBOX
16	1	HOSE VALVE ASSEMBLY
17	1	CONTROL PANEL
18	4	BEZEL,MAIN BURNER CONTROL KNOB
19	4	CONTROL KNOB, MAIN BURNER
20	1	SWITCH
21	2	SWITCH WIRE
22	3	CARRY OVER TUBE
23	4	TUBE BURNER w/ELECTRODE
24	1	RIGHT SIDE SHELF SUPPORT BRACE
25	1	RIGHT SIDE SHELF
26	1	RIGHT SHELF FASCIA
27	3	TOOL HOOKS
28	1	SIDEBURNER LID
29	1	SIDEBURNER GRATE
30	1	SIDEBURNER DRIP PAN
31	1	LEFT SIDE SHELF
32	1	LEFT SIDE SHELF SUPPORT BRACE
33	1	BEZEL, SIDEBURNER CONTROL KNOB
34	1	CONTROL KNOB, SIDEBURNER
35	1	LEFT SHELF FASCIA













Key	Qty	Description
36	1	SIDEBURNER
37	1	SIDEBURNER ELECTRODE WIRE
38	1	LEFT CART PANEL
39	1	FRONT DOOR BRACE
40	1	MAGNET ASSEMBLY
41	1	ELECTRONIC IGNITION MODULE
42	1	ELECTRONIC IGNITION CAP
43	1	BACK CART PANEL
44	1	MIDDLE PANEL
45	1	BOTTOM SHELF
46	1	DOOR STOP
47	1	STORAGE SHELF
48	1	DOOR HANDLE
49	2	RIGHT CART PANEL
50	1	DOOR
51	1	REAR CART PANEL
52	1	FRONT CART PANEL
53	1	GAS CYLINDER BELT
54	1	TANK HEAT SHIELD
55	2	GAS TANK SUPPORT BRACE
56	2	GREASE CUP BRACKET
57	1	GREASE CUP
58	2	WHEEL AXLE
59	2	LOCKING CASTER
60	2	WHEEL
61	2	WHEEL CAP
62	1	MATCH HOLDER
63	1	HOSE CLIP

PARTS LIST - 468923525

Key	Qty	Description
1	1	TOP LID
2	1	LID HANDLE
3	1	TEMPERATURE GAUGE
4	1	LOGO PLATE
5	2	RUBBER BUMPER,LID STOP
6	2	TOP LID HARDWARE
7	2	RUBBER BUMPER,LID
8	4	TUBE BURNER BRACE
9	1	IR CLEANING TOOL
10	1	WARMING RACK
11	2	COOKING GRATE BIG
12	1	COOKING GRATE SMALL
13	2	EMITTERS F/COOKING GRATE BIG
14	1	EMITTERS F/COOKING GRATE SMALL
15	1	FIREBOX
16	1	HOSE VALVE REGULATOR ASSEMBLY
17	1	CONTROL PANEL
18	4	BEZEL F/CONTROL KNOB
19	4	CONTROL KNOB
20	1	SWITCH
21	2	SWITCH WIRE
22	3	CARRY OVER TUBE
23	4	TUBE BURNER w/ELECTRODE
24	1	RIGHT SIDE SHELF SUPPORT BRACE
25	1	RIGHT SIDE SHELF
26	1	RIGHT SHELF FASCIA
27	3	TOOL HOOKS
28	1	SIDEBURNER LID
29	1	SIDEBURNER GRATE
30	1	SIDEBURNER DRIP PAN
31	1	LEFT SIDE SHELF
32	1	LEFT SIDE SHELF SUPPORT BRACE
33	1	BEZEL F/SB CONTROL KNOB
34	1	CONTROL KNOB, SIDEBURNER
35	1	LEFT SHELF FASCIA

Key	Qty	Description
36	1	SIDEBURNER
37	1	SIDEBURNER ELECTRODE WIRE
38	1	LEFT CART PANEL
39	1	FRONT DOOR BRACE
40	1	MAGNET ASSEMBLY
41	1	ELECTRONIC IGNITION MODULE
42	1	ELECTRONIC IGNITION CAP
43	1	BACK CART PANEL
44	1	MIDDLE SHELF
45	1	BOTTOM SHELF
46	1	DOOR STOP
47	1	STORAGE SHELF
48	1	DOOR HANDLE
49	2	RIGHT CART PANEL
50	1	DOOR
51	1	REAR CART PANEL
52	1	FRONT CART PANEL
53	1	GAS CYLINDER BELT
54	1	TANK HEAT SHIELD
55	2	GAS TANK SUPPORT BRACE
56	2	GREASE CUP BRACKET
57	1	GREASE CUP
58	2	WHEEL AXLE
59	2	LOCKING CASTER
60	2	WHEEL
61	2	WHEEL CAP
62	1	MATCH HOLDER
63	1	HOSE CLIP

HARDWARE LIST

Key	Description	Picture	Qty
A	Caster pin		1
B	AXLE ROD		2
C	Axle Washer		2
D	Hitch Pin Clip		2
E	Axle Spacer		2
F	1/4-20x1/2" Screw		16
G	1/4 Flange Nut		1
H	#10 Flange Nut		2
J	#10-24x1/2" Machine Screw		28
K	#8x3/8" Sheet Metal Screw		4
L	#10-24x2/5" Machine Screw		4
M	1/4-20x3/4" Screw Assembly		2
N	Al Washer		4
P	Al Washer		6
Q	No.8-32UNC Machine Screw ,SUS		2
R	Venturi Clip		1
S	#8 Wing Nut		1